

ALARM VALVE

MODEL-H



TECHNICAL DATA

MODEL	H
END CONNECTION	Flange X Flange Flange X Groove Groove X Groove
NOMINAL SIZE	200, 150, 100 & 80 NB
MAXIMUM SERVICE PRESSURE	17.5 Bar (250 PSI)*
THREADED OPENING	BSPT
MOUNTING	Vertical
FLANGE CONNECTION	ANSI B16.42 #150 (Flange drilling matching to ANSI B 16.5 # 150)
TRIM	Galvanised fitting with Brass Valves
FACTORY HYDROSTATIC TEST PRESSURE	35Kg./Sq.Cm. (500PSI)
FRictional LOSS IN TERMS OF EQUIVALENT LENGTH OF PIPE (C-120)	200 NB - 7.50 Mtrs. 150 NB - 7 Mtrs. 100 NB - 6.1 Mtrs. 80 NB - 4.7 Mtrs.
FINISH	Red RAL 3000
APPROVAL	UL Listed & FM Approved
ORDERING INFORMATION	Specify Size of valve, Trim details, End Connection & PIPE OD
REFERENCE	NFPA 13 and NFPA 25

* For 200 NB, FM approval is rated upto 200 PSI (14 Bar)

WEIGHT IN KG

Valve Size	Flange X Flange	Flange X Groove	Groove X Groove
200	65	54.0	44.0
150	42	35.8	28.0
100	27	22.1	17.30
80	18	15.0	12.10

GROOVE PIPE SIZE

NORMAL SIZE	Pipe OD in MM
3" (80 NB)	89
4" (100 NB)	114.3
6" (150 NB)	165.1
6" (150 NB)	168.3
8" (200 NB)	219.1

NOTE: FOR 6" (150 NB) STANDARD SUPPLY IS 168.3 MM OD PIPE GROOVE. FOR 165.1MM SPECIFY IN ORDER



DESCRIPTION

Alarm Valve is a double seated clapper check valve with grooved seat design, which ensures positive water flow for alarm operation and is designed for installation in wet pipe sprinkler system. External bypass prevents false alarm under all supply pressure condition. In the event of variable pressure condition, false alarm is prevented with the provision of retard chamber, thus the design allows for installation under both variable and constant supply pressure condition.

Operation of one or more automatic fire sprinklers causes the water to flow into the sprinkler system causing the alarm valve to open, allowing continuous flow of water into the system and transmittal of alarm, both electrical and mechanical.

OPERATION

The fire protection system initially when being pressurized, will allow water to flow into the system until the water supply and system pressure is equalized and the clapper closes the waterway. Once the pressure is stabilized, the fire protection system is ready to be placed in service and then the alarm control valve must be opened. Under normal condition, the water pressure gauge connected to the system side of the alarm valve would show a higher or equal pressure reading than the water pressure gauge connected to the supply side of the valve. This occurs because of the bypass line connecting downstream and upstream side of the alarm valve, which allows water pressure surge to pass without lifting the valve clapper off its seat, thereby causing excessive high pressure surge entrapped in the system side due to presence of a check valve, which generally prevents false alarm.

Sudden high pressure surge, as might be encountered by the start-up of a large fire pump may lead the valve clapper to lift momentarily, allowing water to

flow through grooves in the valve seat to the retard chamber. The water in the alarm line is automatically drained out, which helps to prevent false alarm due to successive transient surge in supply pressure. Restriction assembly located beneath the retard chamber consists of inlet and drain restriction orifices, which are established by considering the volume of the retard chamber to meet the listing and approval requirement with regard to time-to-alarm. These requirements represent a balancing of the need to reduce the possible false alarm due to a transient surge in supply pressure and to achieve desired minimum time- to- alarm following a sprinkler operation.

In constant pressure installation, the retard chamber is not required and the water passing through the groove in the alarm valve seat flows directly through restriction nozzle assembly to activate the mechanical and electrical alarm.

INSTALLATION

1. HD Sprinkler alarm valve, Model-H must be installed vertically.
2. The alarm valve must be installed in a readily visible and accessible location and provision to be made in such a way that alarm line drain is visible and accessible.
3. Where water pressure fluctuates, the variable pressure trim with retard chamber must be used. Under non-fluctuating water pressure condition, the constant pressure trim, which does not include retard chamber, may be used.
4. The valve must be installed with trim in accordance with the trim data. Failure to follow the appropriate trim connection guidelines may prevent the device from functioning properly as well as void listing, approval and the manufacturer's warranty.
5. Care must be exercised while installing the check valve in the trim to ascertain that they are located with the arrow mark on the check valve body and pointed in proper direction.
6. The contraction and expansion associated with an excessive volume of trapped air could cause the waterway clapper to cycle open and shut. This may result in false alarm or an intermittent alarm. To avoid these, it is recommended to have breather valve in the system piping network and a vent valve at the extreme end of the system to bleed-off the air.
7. The ball valve provided on the alarm line must be kept open and strapped in set position.
8. Pipe connecting the retard chamber and sprinkler alarm bell must be supported properly to avoid loading on the retard chamber.

9. All the newly installed system pipes must be flushed properly before alarm valve is put into service.

INSPECTION AND MAINTENANCE

A qualified and trained person must commission the system. After few initial successful tests an authorised person must be trained to perform inspection and testing of the system.

It is recommended to carry out physical inspection of the system at least twice a week. The inspection should verify that all the control valves are in proper position as per the requirement of the system and no damage has taken place to any component.

It is recommended that the alarm valve and its accessories should be examined and performed for following at least quarterly or as demanded by local authorities to ensure reliable and trouble free operation and service.

1. Inspection and testing is to be carried out only by an authorized person. DO NOT TURN OFF the water supply valve to undertake repair work or to test the valve, without placing a roving fire patrol in the area covered by the system. The patrol should continue until the system is back into service. Also do inform the local security personnel and alarm control station, so that a false alarm is not signaled.
2. Open the alarm test valve. Verify that the sprinkler alarm bell and/or the pressure alarm switch/ electric alarm properly actuate. Close the alarm test valve and verify that water has ceased to flow from the alarm line drain.
3. Clean the 20 NB (3/4") strainer provided on the sprinkler alarm bell line.
4. Clean the strainer of restriction assembly.
5. Inspect the check valve clapper located on the bypass line.

FALSE ALARM

1. Inspect the valve rubber clapper face. If worn or damaged, replace it. Be certain that dirt, stone or any other foreign object have not accumulated under the clapper face and lodged in the groove or holes. Clean the clapper face thoroughly. If the seat ring surface is nicked or scoured, it might be possible to repair the same using lapping compound. If not, replace the complete valve or return it to the manufacturer's works for repair.
2. If sprinkler alarm bell is not functioning or the impeller is jammed, please follow the maintenance guideline provided in the catalogue for sprinkler alarm bell.

3. If pressure alarm switch gives a steady signal, but sprinkler alarm generates an intermittent alarm, check sprinkler alarm bell shaft. If both the sprinkler alarm bell and pressure alarm switch are generating intermittent alarm then check for the possible air which is trapped within the sprinkler system. Trapped air is to be bled off. Also the intermittent alarm may occur due to sudden pressure drop and increase in the system. These problems can be corrected by maintaining a steady supply.

CAUTION

1. The UL Listing, FM Approval and manufacturer's warranty are valid only when the alarm valve is installed with HD trim set and installed as per installation guidelines.
2. Pressure relief valve is required with wet pipe system, when a rise in ambient temperature can cause system pressure to exceed 17.5 Bar (250 PSI). A 17.7 Bar relief valve setting should be used.
3. For proper operation of the wet system and to minimize unwanted false alarm, it is important to remove trapped air from the system. The air trapped in the system may also cause intermittent operation of the Water Motor Alarm during sustained flow of water.

Nominal Pressure Loss vs Flow - Alarm Valve (Model H)

Nominal Pressure Loss vs Flow - Alarm Valve AV-H

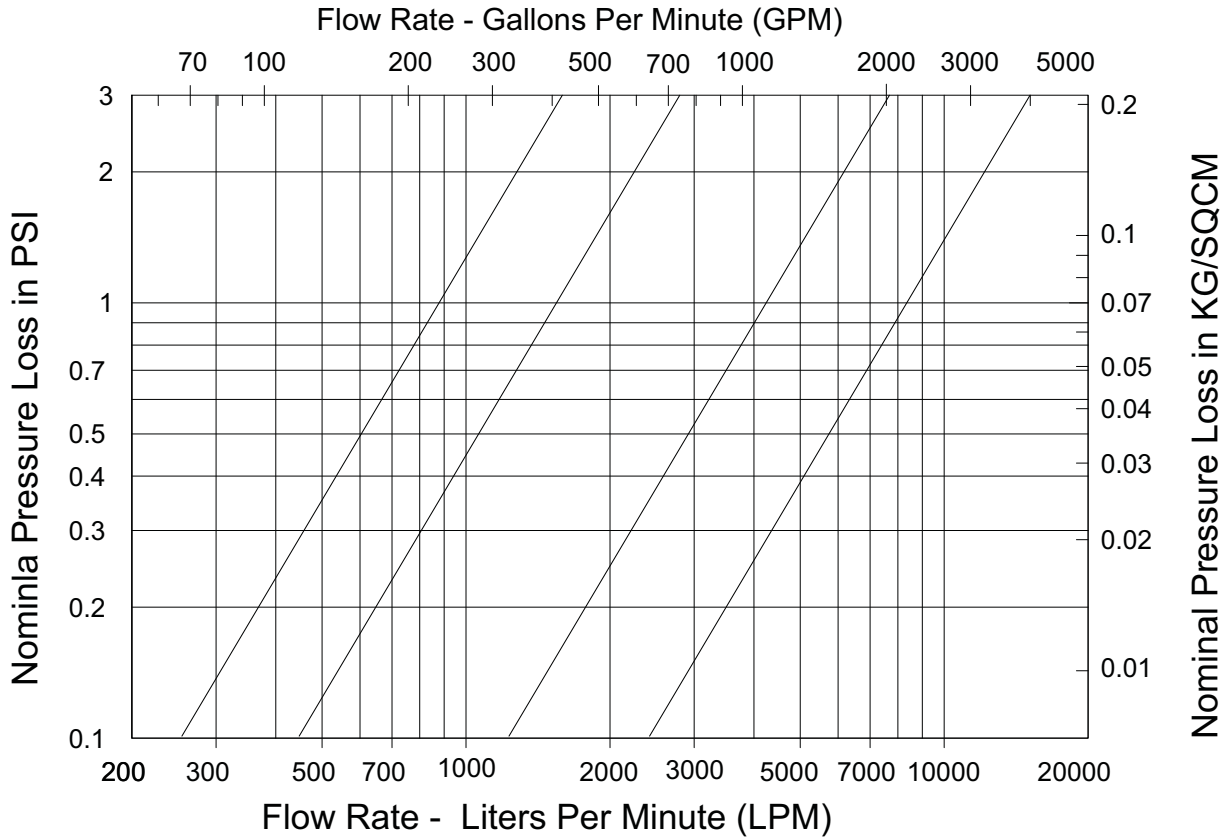

ALARM VALVE, MODEL - H SIZE 200 / 150 / 100 / 80 NB

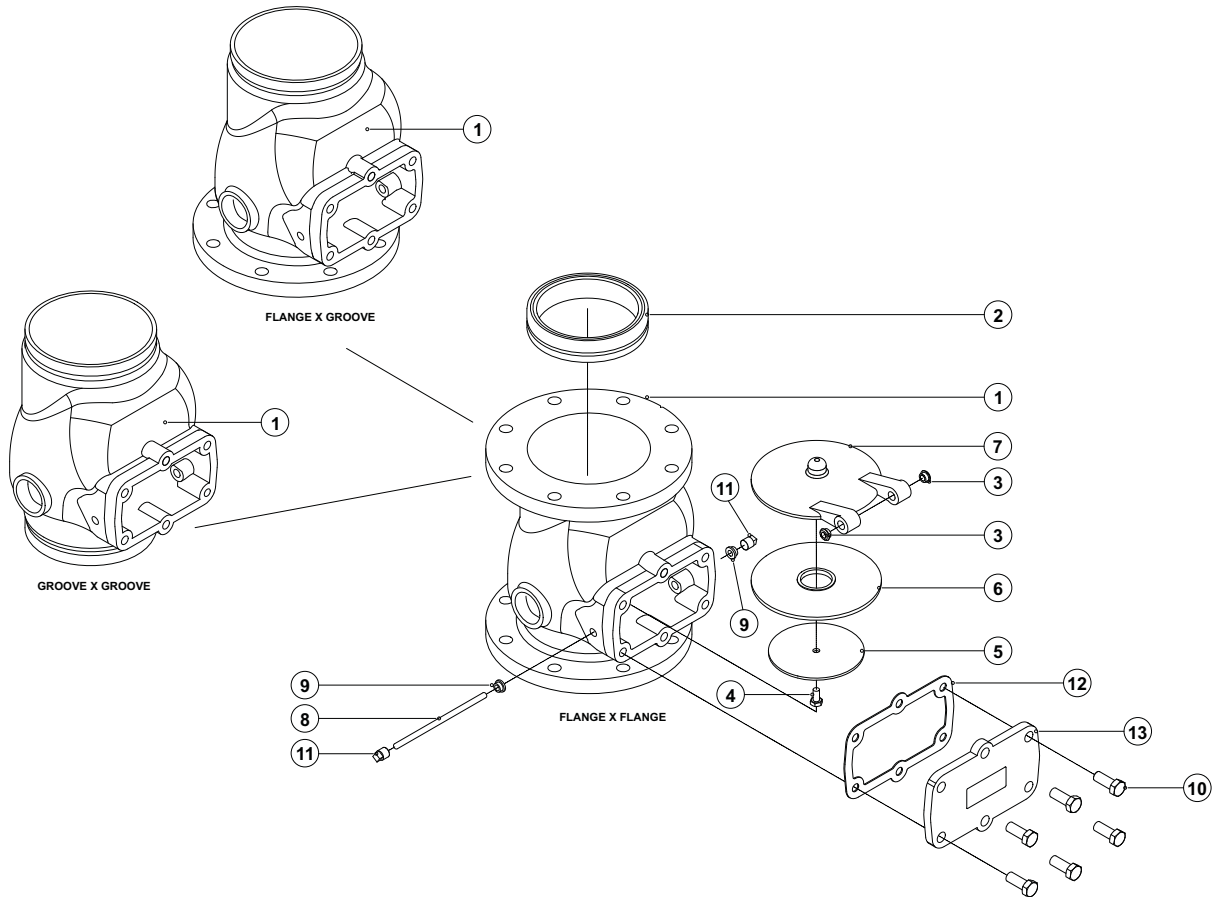

PART LIST

ITEM					DESCRIPTION					MATERIAL SPECIFICATION
	200 NB	150 NB	100 NB	80 NB		200 NB	150 NB	100 NB	80 NB	
1	NA	NA	NA	NA	HOUSING (FLANGE X FLANGE)	1	1	1	1	DUCTILE IRON
1	2478	2471	2469	2468	HOUSING (FLANGE X GROOVE)	1	1	1	1	DUCTILE IRON
1	2485	2482	2480	2479	HOUSING (GROOVE X GROOVE)	1	1	1	1	DUCTILE IRON
2	NA	NA	NA	NA	SEAT	1	1	1	1	BRONZE
3	2600	2600	2600	2600	CLAPPER BUSH	2	2	2	2	BRASS
4	9102	9101	9101	9101	HEX. HEAD BOLT	4	1	1	1	STAINLESS STEEL
5	2636	2628	2619	2656	RUBBER CLAMP	1	1	1	1	STAINLESS STEEL
6	2635	2606	2618	2655	RUBBER SEAT	1	1	1	1	NEOPRENE RUBBER
7	2634	2603	2617	2654	CLAPPER	1	1	1	1	DUCTILE IRON
8	2638	2608	2258	2658	HINGE PIN	1	1	1	1	STAINLESS STEEL
9	2599	2599	2599	2599	BODY BUSH	2	2	2	2	BRASS
10	9004	9004	9004	8373	HEX. HEAD BOLT	6	6	4	4	STEEL
11	9430	9430	9430	9430	SQ. HEAD PLUG	2	2	2	2	FORGED STEEL
12	2637	2611	2620	2657	COVER GASKET	1	1	1	1	NEOPRENE RUBBER
13	2631	2604	2615	2651	COVER	1	1	1	1	DUCTILE IRON

NA : PARTS REPLACEMENT NOT AVAILABLE

**CONSTANT PRESSURE TRIM FOR ALARM VALVE MODEL - H
200 / 150 / 100 / 80 NB**

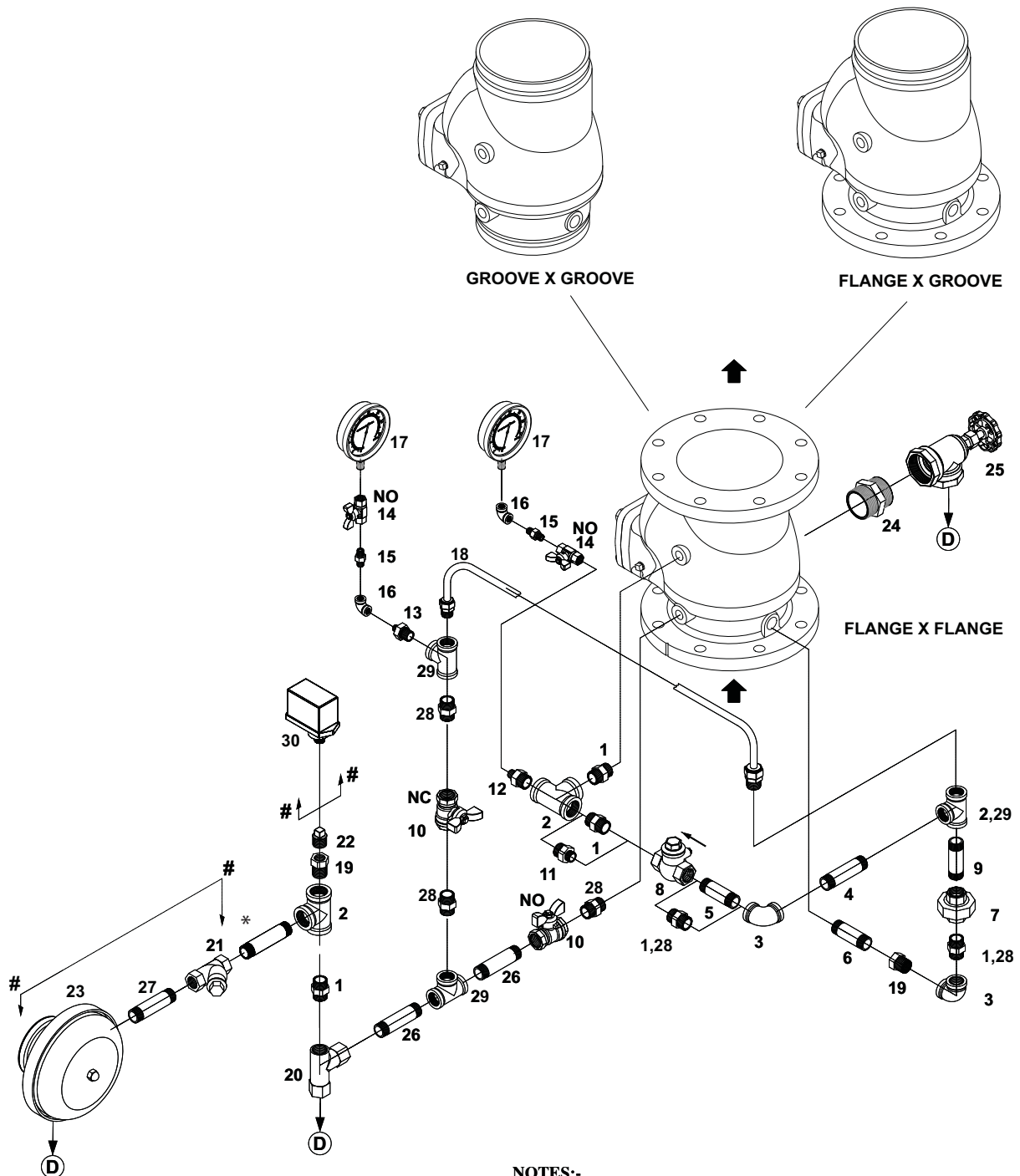

NOTES:-

- # OPTIONAL TRIM ORDERED SEPERATELY
 - D DRAIN
 - * TO SUIT AT SITE BY INSTALLER
 - NO - NORMALLY OPEN
 - NC - NORMALLY CLOSED
- WHEN PRESSURE SWITCH IS SUPPLIED THEN SL.NO.22 PLUG NOT REQUIRED.

**CONSTANT PRESSURE TRIM FOR ALARM VALVE MODEL - H
200 / 150 / 100 / 80 NB**

ITEM NO.	CODE NO.	DESCRIPTION	SIZE	QUANTITY PER ALARM VALVE SIZE			
				200NB	150NB	100NB	80NB
1	8625	HEX NIPPLE	3/4"	4	4	5	2
2	8620	TEE	3/4"	3	3	3	2
3	8617	ELBOW	3/4"	2	2	2	-
3	8616	ELBOW	1/2"	-	-	-	2
4	8951	PIPE NIPPLE	3/4" X 150 MM LONG	1	-	-	-
4	9407	PIPE NIPPLE	3/4" X 130 MM LONG	-	1	-	-
4	9406	PIPE NIPPLE	3/4" X 100 MM LONG	-	-	1	-
4	9397	PIPE NIPPLE	1/2" X 100 MM LONG	-	-	-	1
5	9406	PIPE NIPPLE	3/4" X 80 MM LONG	1	-	-	-
5	9441	PIPE NIPPLE	3/4" X 80 MM LONG	-	1	-	-
6	9397	PIPE NIPPLE	1/2" X 100 MM LONG	1	-	-	1
6	9480	PIPE NIPPLE	1/2" X 80 MM LONG	-	1	1	-
7	8628	UNION	3/4"	1	1	1	-
7	8627	UNION	1/2"	-	-	-	1
8	9421	SWING CHECK VALVE	3/4"	1	1	1	-
8	9455	SWING CHECK VALVE	1/2"	-	-	-	1
9	8663	PIPE NIPPLE	3/4" X 70MM LONG	1	1	-	-
9	9426	PIPE NIPPLE	3/4" X 60MM LONG	-	-	1	-
9	9893	PIPE NIPPLE	1/2" X 70MM LONG	-	-	-	1
10	9423	BALL VALVE	1/2"	2	2	2	2
11	8633	REDUCING HEX NIPPLE	3/4" X 1/2"	-	-	-	1
12	8632	REDUCING HEX NIPPLE	3/4" X 1/4"	1	1	1	1
13	8631	REDUCING HEX NIPPLE	1/2" X 1/4"	1	1	1	1
14	9477	BALL VALVE	1/4"	2	2	2	2
15	8698	HEX NIPPLE	1/4"	2	2	2	2
16	8357	ELBOW	1/4"	2	2	2	2
17	9526	PRESSURE GUAGE	1/4"	2	2	2	2
18	2301	ALARM TEST LINE ASSEMBLY	1/2"	-	-	-	1
18	2302	ALARM TEST LINE ASSEMBLY	1/2"	-	-	1	-
18	2303	ALARM TEST LINE ASSEMBLY	1/2"	-	1	-	-
18	2304	ALARM TEST LINE ASSEMBLY	1/2"	1	-	-	-
19	8355	REDUCING BUSH	3/4" X 1/2"	2	2	2	1
20	1027	RESTRICTION NOZZLE ASSEMBLY	'HD' MAKE	1	1	1	1
21	9382	'Y' TYPE STRAINER	3/4"	1	1	1	1
22	8629	PLUG	1/2"	1	1	1	1
23	1416	SPRINKLER ALARM	'HD' MAKE TYPE 'A'	1	1	1	1
23	1417	SPRINKLER ALARM	'HD' MAKE TYPE 'B'	1	1	1	1
24	8359	HEX NIPPLE	2"	1	1	1	-
24	8360	HEX NIPPLE	1-1/4"	-	-	-	1
25	9394	ANGLE VALVE	2"	1	1	1	-
25	9392	ANGLE VALVE	1-1/4"	-	-	-	1
26	9561	PIPE NIPPLE	1/2" X 60MM LONG	2	2	2	2
27	9441	PIPE NIPPLE	3/4" X 80MM LONG	1	1	1	1
28	8624	HEX NIPPLE	1/2"	3	3	3	5
29	8619	TEE	1/2"	2	2	2	3
30	-	PRESSURE SWITCH (OPTIONAL)	1/2" END CONNECTION	1	1	1	1

**VARIABLE PRESSURE TRIM FOR ALARM VALVE MODEL - H
200 / 150 / 100 / 80 NB**

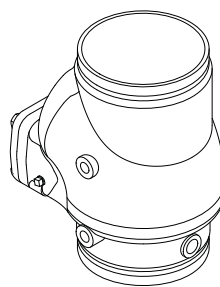

GROOVE X GROOVE

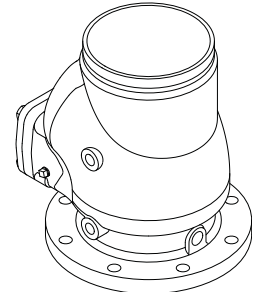

FLANGE X GROOVE

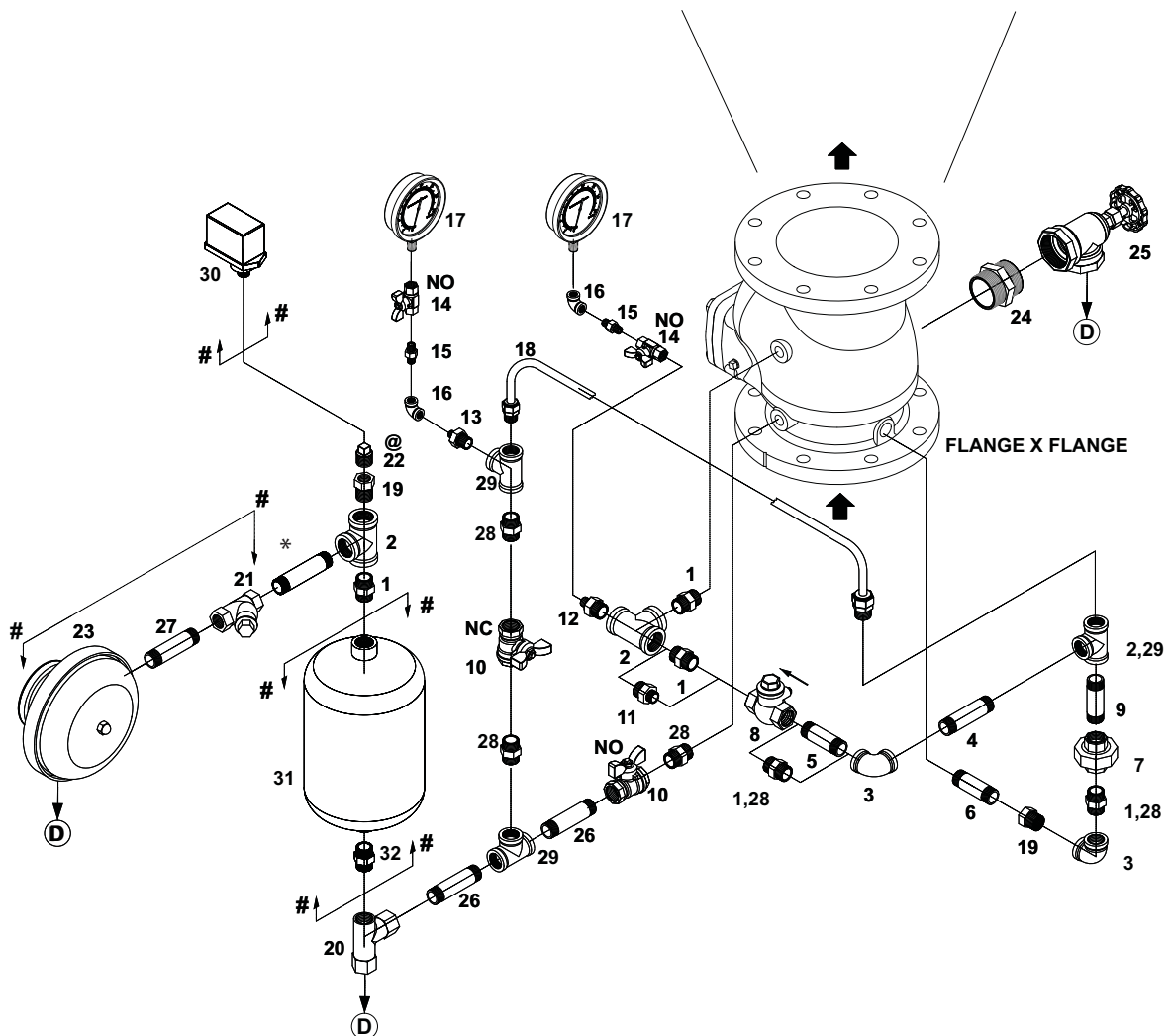

NOTES:-

OPTIONAL TRIM ORDERED SEPERATELY

Ⓧ DRAIN

* TO SUIT AT SITE BY INSTALLER

NO - NORMALLY OPEN

NC - NORMALLY CLOSED

WHEN PRESSURE SWITCH IS SUPPLIED THEN SL.NO.22 PLUG NOT REQUIRED.

**VARIABLE PRESSURE TRIM FOR ALARM VALVE MODEL - H
200 / 150 / 100 / 80 NB**

ITEM NO.	CODE NO.	DESCRIPTION	SIZE	QUANTITY PER ALARM VALVE SIZE			
				200NB	150NB	100NB	80NB
1	8625	HEX NIPPLE	3/4"	4	4	5	2
2	8620	TEE	3/4"	3	3	3	2
3	8617	ELBOW	3/4"	2	2	2	-
3	8616	ELBOW	1/2"	-	-	-	2
4	8951	PIPE NIPPLE	3/4" X 150 MM LONG	1	-	-	-
4	9407	PIPE NIPPLE	3/4" X 130 MM LONG	-	1	-	-
4	9406	PIPE NIPPLE	3/4" X 100 MM LONG	-	-	1	-
4	9397	PIPE NIPPLE	1/2" X 100 MM LONG	-	-	-	1
5	9406	PIPE NIPPLE	3/4" X 100 MM LONG	1	-	-	-
5	9441	PIPE NIPPLE	3/4" X 80 MM LONG	-	1	-	-
6	9397	PIPE NIPPLE	1/2" X 100 MM LONG	1	-	-	1
6	9480	PIPE NIPPLE	1/2" X 80 MM LONG	-	1	1	-
7	8628	UNION	3/4"	1	1	1	-
7	8627	UNION	1/2"	-	-	-	1
8	9421	SWING CHECK VALVE	3/4"	1	1	1	-
8	9455	SWING CHECK VALVE	1/2"	-	-	-	1
9	8663	PIPE NIPPLE	3/4" X 70MM LONG	1	1	-	-
9	9426	PIPE NIPPLE	3/4" X 60MM LONG	-	-	1	-
9	9893	PIPE NIPPLE	1/2" X 70MM LONG	-	-	-	1
10	9423	BALL VALVE	1/2"	2	2	2	2
11	8633	REDUCING HEX NIPPLE	3/4" X 1/2"	-	-	-	1
12	8632	REDUCING HEX NIPPLE	3/4" X 1/4"	1	1	1	1
13	8631	REDUCING HEX NIPPLE	1/2" X 1/4"	1	1	1	1
14	9477	BALL VALVE	1/4"	2	2	2	2
15	8698	HEX NIPPLE	1/4"	2	2	2	2
16	8357	ELBOW	1/4"	2	2	2	2
17	9526	PRESSURE GUAGE	1/4"	2	2	2	2
18	2301	ALARM TEST LINE ASSEMBLY	1/2"	-	-	-	1
18	2302	ALARM TEST LINE ASSEMBLY	1/2"	-	-	1	-
18	2303	ALARM TEST LINE ASSEMBLY	1/2"	-	1	-	-
18	2304	ALARM TEST LINE ASSEMBLY	1/2"	1	-	-	-
19	8355	REDUCING BUSH	3/4" X 1/2"	2	2	2	1
20	1027	RESTRICTION NOZZLE ASSEMBLY	'HD' MAKE	1	1	1	1
21	9382	'Y' TYPE STRAINER	3/4"	1	1	1	1
22	8629	PLUG	1/2"	1	1	1	1
23	1416	SPRINKLER ALARM	'HD' MAKE TYPE 'A'	1	1	1	1
23	1417	SPRINKLER ALARM	'HD' MAKE TYPE 'B'	1	1	1	1
24	8359	HEX NIPPLE	2"	1	1	1	-
24	8360	HEX NIPPLE	1-1/4"	-	-	-	1
25	9394	ANGLE VALVE	2"	1	1	1	-
25	9392	ANGLE VALVE	1-1/4"	-	-	-	1
26	9561	PIPE NIPPLE	1/2" X 60MM LONG	2	2	2	2
27	9441	PIPE NIPPLE	3/4" X 80MM LONG	1	1	1	1
28	8624	HEX NIPPLE	1/2"	3	3	3	5
29	8619	TEE	1/2"	2	2	2	3
30	-	PRESSURE SWITCH (OPTIONAL)	1/2" END CONNECTION	1	1	1	1
31	2300	RETARD CHAMBER, MODEL - RC9	'HD' MAKE	1	1	1	1
32	8625	HEX NIPPLE	3/4"	1	1	1	1



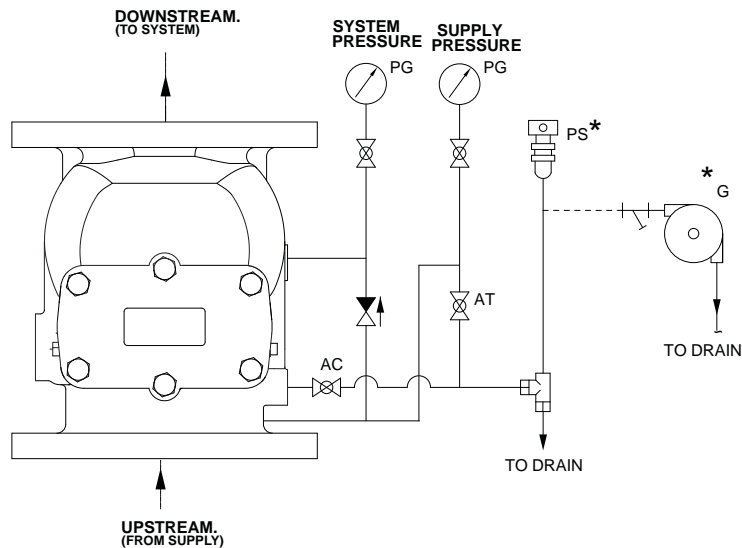

CONSTANT PRESSURE TRIM - SCHEMATIC
ALARM VALVE MODEL - H FLANGE X FLANGE 200 / 150 / 100 / 80 NB

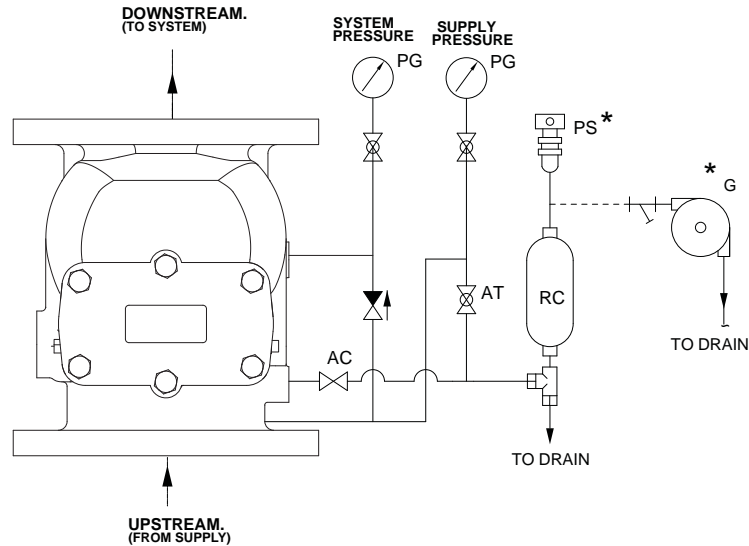

VARIABLE PRESSURE TRIM - SCHEMATIC
ALARM VALVE MODEL - H FLANGE X FLANGE 200 / 150 / 100 / 80 NB



ABBREVIATION & SYMBOLS

	NON RETURN VALVE		RESTRICTION NOZZLE ASSEMBLY	AV	ALARM VALVE
	VALVE	*	OPTIONAL	G	SPRINKLER ALARM
	ANGLE VALVE	NO	NORMALLY OPEN	PS	PRESSURE SWITCH
	STRAINER	OD	OPEN DRAIN	RC	RETARD CHAMBER
NC	NORMALLY CLOSED	PG	PRESSURE GAUGE	AT	SPRINKLER ALARM TEST VALVE
AC	SPRINKLER ALARM CONTROL VALVE	---	BY USER (NOT IN 'HD' SCOPE OF SUPPLY)		

NOTE :-

1) SPRINKLER ALARM CONTROL VALVE MUST BE KEPT NORMALLY OPEN IF THIS VALVE IS KEPT CLOSED THE SPRINKLER ALARM BELL/ ELECTRIC ALARM WILL NOT SIGNAL.

2) SPRINKLER ALARM TEST VALVE MUST BE KEPT NORMALLY CLOSED CONDITION. VALVE IS OPENED TO TEST THE SPRINKLER ALARM BELL / ELECTRIC ALARM.



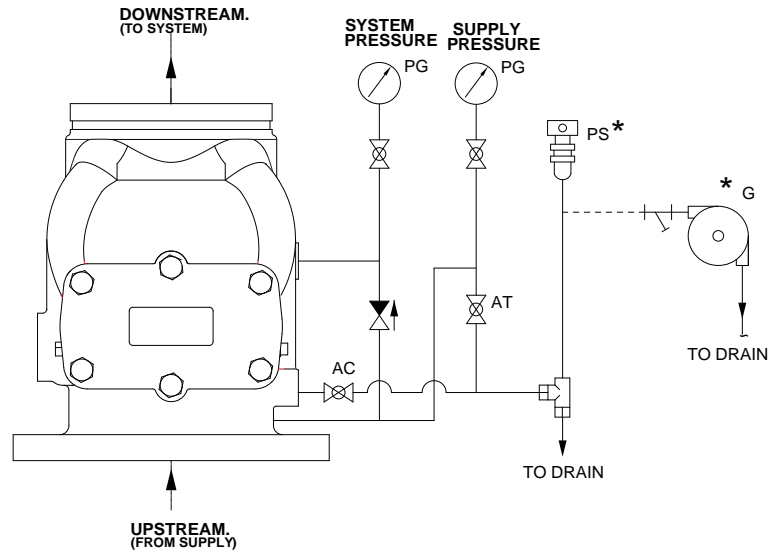



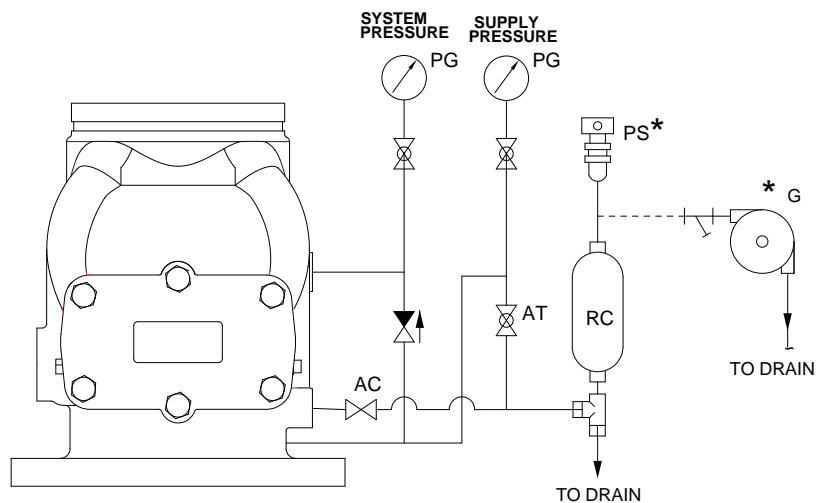



CONSTANT PRESSURE TRIM - SCHEMATIC
ALARM VALVE MODEL - H FLANGE X GROOVE 200 / 150 / 100 / 80 NB



VARIABLE PRESSURE TRIM - SCHEMATIC
ALARM VALVE MODEL - H FLANGE X GROOVE 200 / 150 / 100 / 80 NB



ABBREVIATION & SYMBOLS

	NON RETURN VALVE		RESTRICTION NOZZLE ASSEMBLY		ALARM VALVE
	VALVE	*	OPTIONAL		SPRINKLER ALARM
	ANGLE VALVE	NO	NORMALLY OPEN		PRESSURE SWITCH
	STRAINER	OD	OPEN DRAIN		RETARD CHAMBER
NC	NORMALLY CLOSED	PG	PRESSURE GAUGE		SPRINKLER ALARM TEST VALVE
AC	SPRINKLER ALARM CONTROL VALVE	---	BY USER (NOT IN 'HD' SCOPE OF SUPPLY)		

NOTE :-

- 1) SPRINKLER ALARM CONTROL VALVE MUST BE KEPT NORMALLY OPEN IF THIS VALVE IS KEPT CLOSED THE SPRINKLER ALARM BELL/ ELECTRIC ALARM WILL NOT SIGNAL.
- 2) SPRINKLER ALARM TEST VALVE MUST BE KEPT NORMALLY CLOSED CONDITION. VALVE IS OPENED TO TEST THE SPRINKLER ALARM BELL / ELECTRIC ALARM.



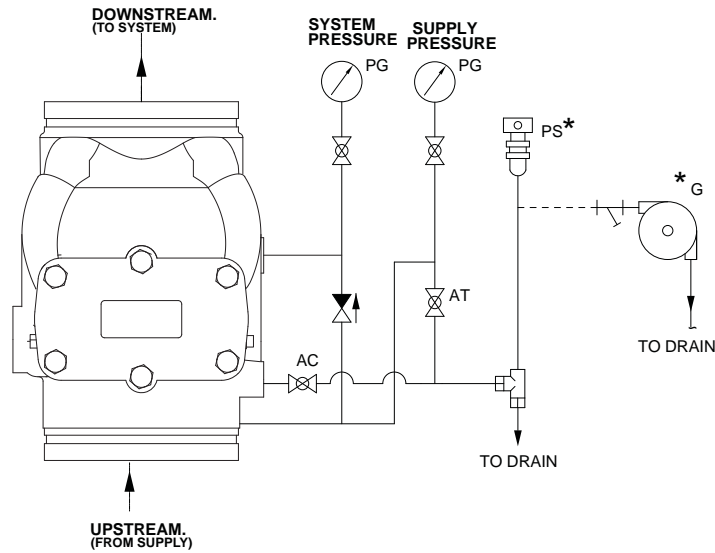

CONSTANT PRESSURE TRIM - SCHEMATIC
ALARM VALVE MODEL - H GROOVE X GROOVE 200 / 150 / 100 / 80 NB

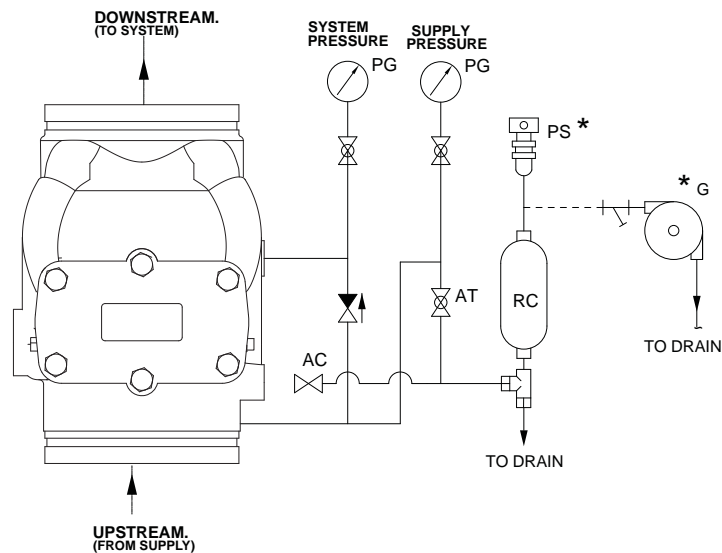

VARIABLE PRESSURE TRIM - SCHEMATIC
ALARM VALVE MODEL - H GROOVE X GROOVE 200 / 150 / 100 / 80 NB



ABBREVIATION & SYMBOLS

	NON RETURN VALVE		RESTRICTION NOZZLE ASSEMBLY	AV	ALARM VALVE
	VALVE	*	OPTIONAL	G	SPRINKLER ALARM
	ANGLE VALVE	NO	NORMALLY OPEN	PS	PRESSURE SWITCH
	STRAINER	OD	OPEN DRAIN	RC	RETARD CHAMBER
NC	NORMALLY CLOSED	PG	PRESSURE GAUGE	AT	SPRINKLER ALARM TEST VALVE
AC	SPRINKLER ALARM CONTROL VALVE	---	BY USER (NOT IN 'HD' SCOPE OF SUPPLY)		

NOTE :-

1) SPRINKLER ALARM CONTROL VALVE MUST BE KEPT NORMALLY OPEN IF THIS VALVE IS KEPT CLOSED THE SPRINKLER ALARM BELL/ ELECTRIC ALARM WILL NOT SIGNAL.

2) SPRINKLER ALARM TEST VALVE MUST BE KEPT NORMALLY CLOSED CONDITION. VALVE IS OPENED TO TEST THE SPRINKLER ALARM BELL / ELECTRIC ALARM.

**INSTALLATION DIMENSION WITH TRIM
ALARM VALVE MODEL - H FLANGE X FLANGE 200 / 150 / 100 / 80 NB**

A) CONSTANT PRESSURE TRIM

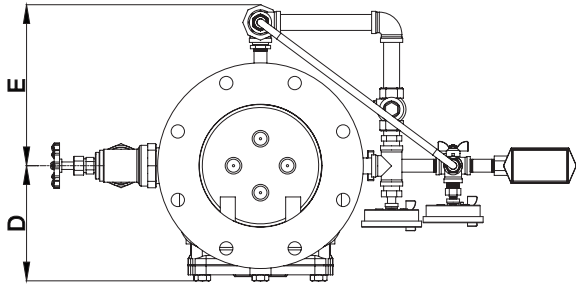

WITH CONSTANT PRESSURE TRIM				
SIZE	80NB	100NB	150NB	200NB
A	279	312	331	350
B	457	464	486	527
C	434	434	434	443
D	127	140	173	192
E	201	219	234	269
F	262	274	315	378

DIMENSIONS are approx. and in millimeters

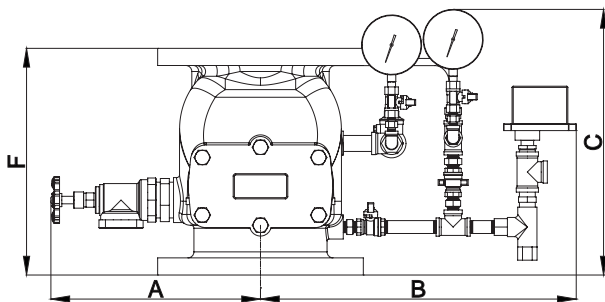

B) VARIABLE PRESSURE TRIM

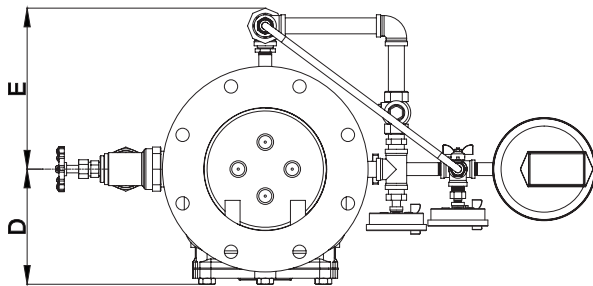

WITH VARIABLE PRESSURE TRIM				
SIZE	80NB	100NB	150NB	200NB
A	279	312	331	350
B	482	488	510	551
C	588	588	588	597
D	127	140	173	192
E	201	219	234	269
F	262	274	315	378

DIMENSIONS are approx. and in millimeters

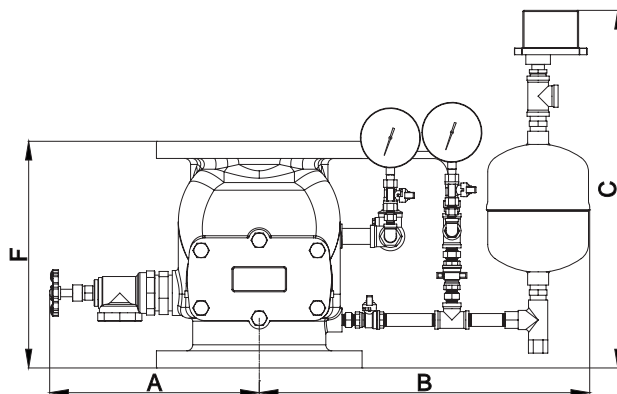

**INSTALLATION DIMENSION WITH TRIM
ALARM VALVE MODEL - H FLANGE X GROOVE 200 / 150 / 100 / 80 NB**

A) CONSTANT PRESSURE TRIM

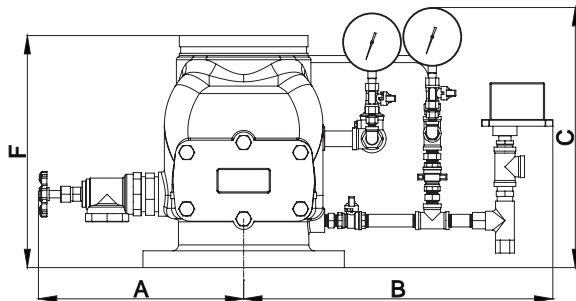
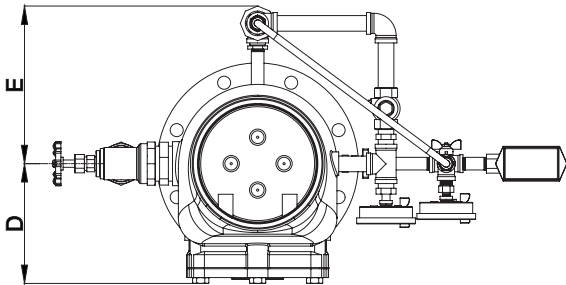

WITH CONSTANT PRESSURE TRIM				
SIZE	80NB	100NB	150NB	200NB
A	279	312	331	350
B	457	464	486	527
C	434	434	434	443
D	127	140	173	204
E	201	219	234	269
F	275	291.3	316.8	395.2

DIMENSIONS are approx. and in millimeters

B) VARIABLE PRESSURE TRIM

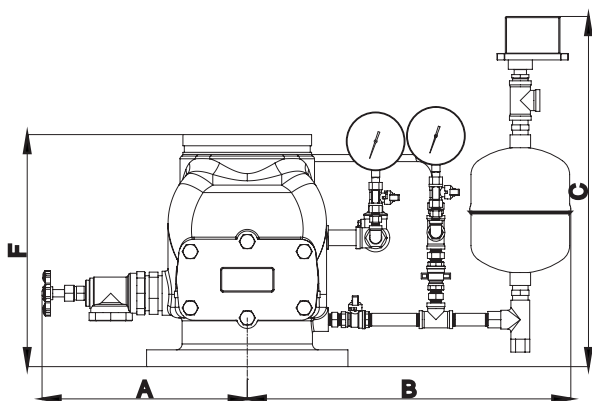
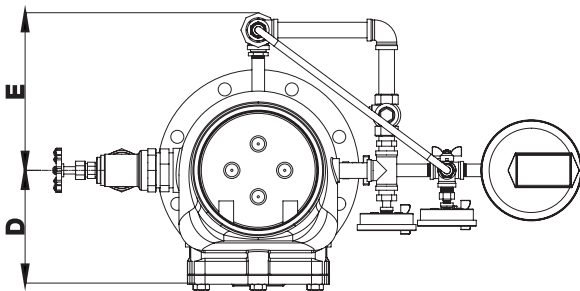

WITH VARIABLE PRESSURE TRIM				
SIZE	80NB	100NB	150NB	200NB
A	279	312	331	350
B	482	488	510	551
C	588	588	588	597
D	127	140	173	204
E	201	219	234	269
F	275	291.3	316.8	395.2

DIMENSIONS are approx. and in millimeters

**INSTALLATION DIMENSION WITH TRIM
ALARM VALVE MODEL - H GROOVE X GROOVE 200 / 150 / 100 / 80 NB**

A) CONSTANT PRESSURE TRIM

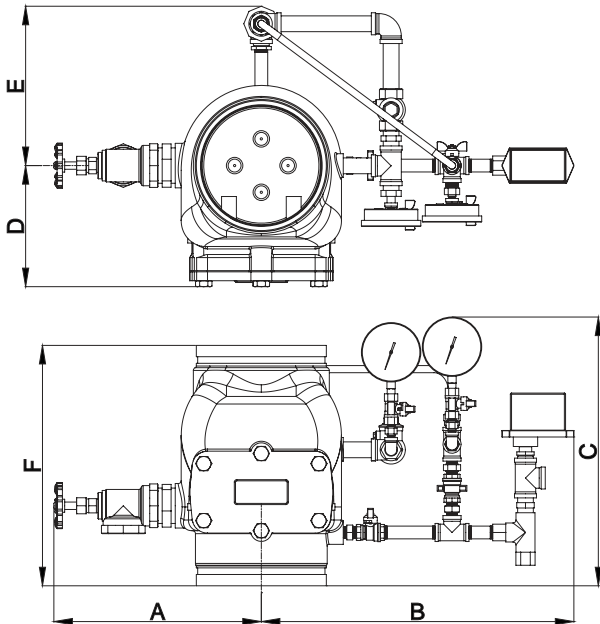

WITH CONSTANT PRESSURE TRIM				
SIZE	80NB	100NB	150NB	200NB
A	279	312	331	350
B	457	464	486	527
C	439	443	442	443
D	127	140	173	204
E	201	219	234	269
F	280	300	324	405

DIMENSIONS are approx. and in millimeters

B) VARIABLE PRESSURE TRIM

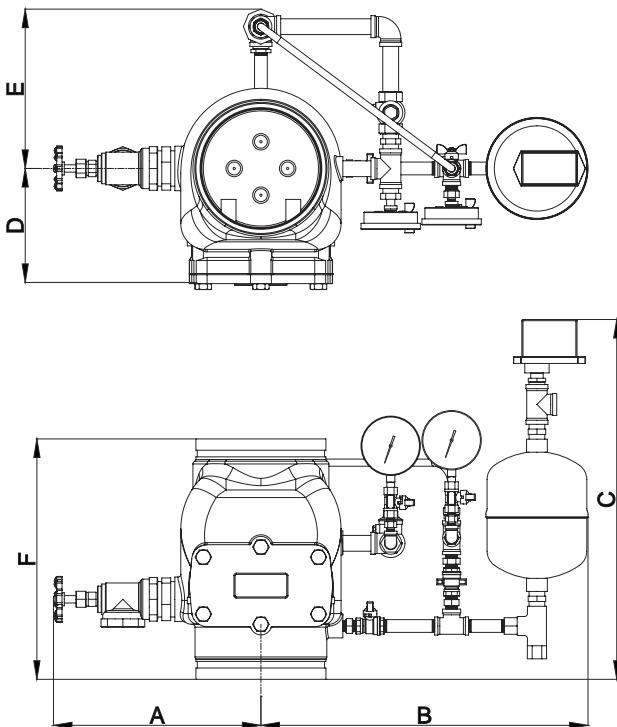

WITH VARIABLE PRESSURE TRIM				
SIZE	80NB	100NB	150NB	200NB
A	279	312	331	350
B	482	488	510	551
C	593	596	596	607
D	127	140	173	204
E	201	219	234	269
F	280	300	324	405

DIMENSIONS are approx. and in millimeters

LIMITED WARRANTY

HD FIRE PROTECT PVT. LTD. hereby referred to as HD FIRE warrants to the original purchaser of the fire protection products manufactured by HD FIRE and to any other person to whom such equipment is transferred, that such products will be free from defect in material and workmanship under normal use and care, for two (2) years from the date of shipment by HD FIRE. Products or Components supplied or used by HD FIRE, but manufactured by others, are warranted only to the extent of the manufacturer's warranty. No warranty is given for product or components which have been subject to misuse, improper installation, corrosion, unauthorized repair, alteration or un-maintained. HD FIRE shall not be responsible for system design errors or improper installation or inaccurate or incomplete information supplied by buyer or buyer's representatives. HD FIRE will repair or replace defective material free of charge, which is returned to our factory, transportation charge prepaid, provided after our inspection the material is found to have been defective at the time of initial shipment from our works. HD FIRE shall not be liable for any incidental or consequential loss, damage or expense arising directly or indirectly from the use of the product including damages for injury to person, damages to property and penalties resulting from any products and components manufactured by HD FIRE. HD FIRE shall not be liable for any damages or labour charges or expense in making repair or adjustment to the product. HD FIRE shall not be liable for any damages or charges sustained in the adaptation or use of its engineering data & services. In no event shall HD Fire's product liability exceed an amount equal to the sale price. The foregoing warranty is exclusive and in lieu of all other warranties and representation whether expressed, implied, oral or written, including but not limited to, any implied warranties or merchantability or fitness for a particular purpose. All such other warranties and representations are hereby cancelled.

NOTICE :

The equipment presented in this bulletin is to be installed in accordance with the latest publication standards of NFPA or other similar organisations and also with the provision of government codes or ordinances wherever applicable.
The information provided by us are to the best of our knowledge and belief, and are general guidelines only. Site handling and installation control is beyond our reach. Hence we give no guarantee for result and take no liability for damages, loss or penalties whatsoever, resulting from our suggestion, information, recommendation or damages due to our product.
Product development is a continuous programme of HD FIRE PROTECT PVT. LTD. and hence the right to modify any specification without prior notice is reserved with the company.



HD FIRE PROTECT PVT. LTD.
Protecting What Matters Most to You

C-3/6, THE NANDANVAN IND. ESTATE, L. B. S. MARG, THANE 400 604., INDIA.
• PHONES : + (91) 22 2583 5434 • 2582 6958 • 2582 6793
• FAX : +(91) 22 2581 2524 • 6796 9049
• EMAIL : info@hdfire.com WEBSITE : www.hdfire.com