

# Wet and Dry Riser Equipment Fire Hydrant, Standpipe, Hydrant Key & Bar and Adaptor

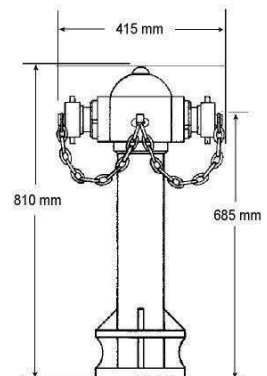

## 2-WAY FIRE HYDRANT (c/w Adaptor & Blank Cap)

Ordering Code	PH 2T
Body Material	Ductile Iron to BS 2789
Outlet Material	Bronze to BS 1400
Inlet	100mm
Outlet	2 x 65 mm Male Vee Blank Caps & chain
Test Pressure	24 Bar
Overall Flow Test	2000 Litres/min @ 1.7 Bar
Paint Finishing	Yellow Or Red



## 2-WAY FIRE HYDRANT (c/w Landing Valve)

Ordering Code	PH 2Q
Body Material	Ductile Iron to BS 2789
Outlet Material	Bronze to BS 1400
Inlet	100mm
Outlet	2 x 65 mm Control valve with female BS 336 Instantaneous outlet
Test Pressure	24 Bar
Overall Flow Test	2000 Litres/min @ 1.7 Bar
Paint Finishing	Yellow Or Red

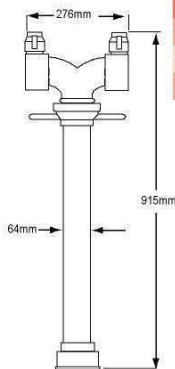
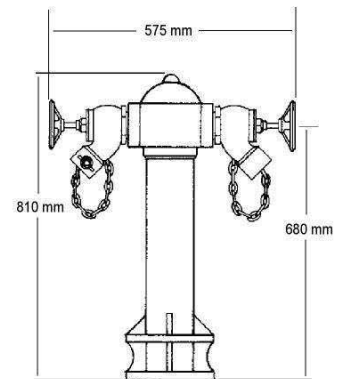

## DOUBLE OUTLET STANDPIPE

Ordering Code	SP 2A
Standpipe Shaft	Aluminium Alloy to BS 1474 or BS 1471
Standpipe Base & Head	Aluminium Alloy to BS 1490 & BS 1400

## SINGLE OUTLET STANDPIPE

Ordering Code	SP 1A
Standpipe Shaft	Aluminium Alloy to BS 1474 or BS 1471
Standpipe Base & Head	Aluminium Alloy to BS 1490 & BS 1400

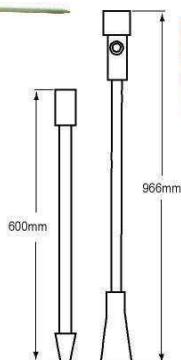
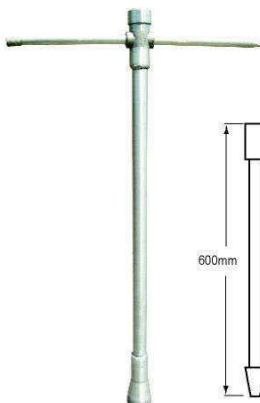
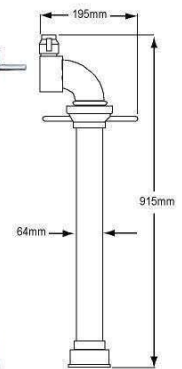

## HYDRANT KEY & BAR

Ordering Code	KBA
Body Material	Aluminium Alloy to BS 1474 or BS 1490

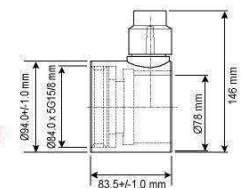

## HYDRANT ADAPTOR

Ordering Code	2DB 91
Body Material	Aluminium Alloy
Size	2 1/2"
Connection	2 1/2" BSPT Female
Colour	Red